

产品细节 Details

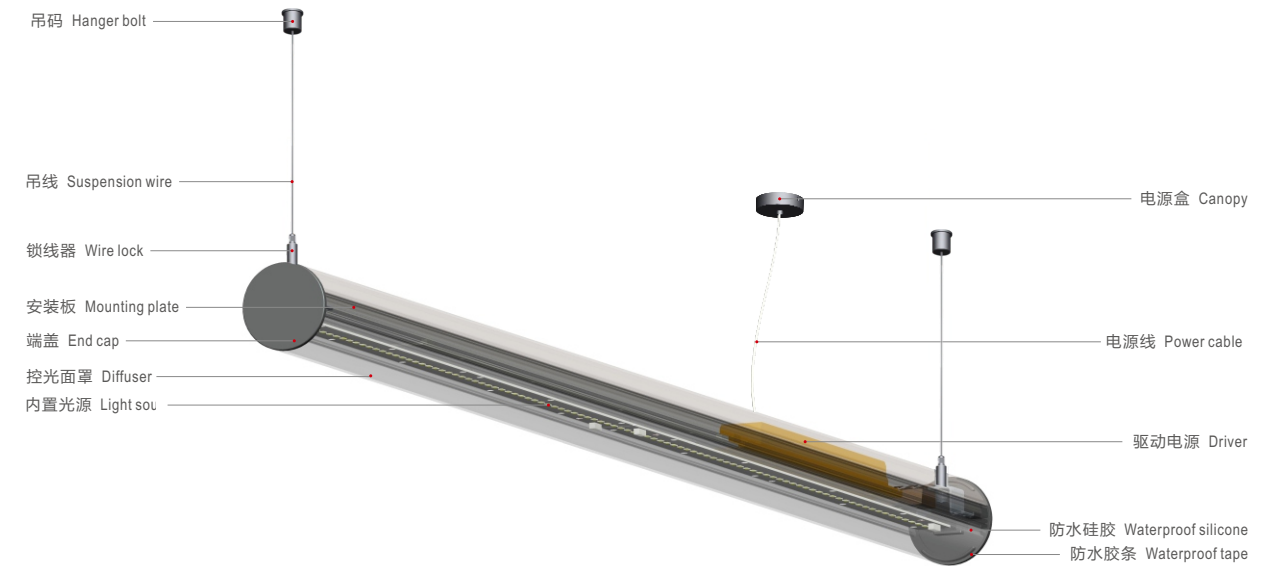

规格参数 Technical Data

名称: 705 吊灯
类型: 吊灯
灯体材料: 优质铝合金
表面处理: 静电喷涂
控光面罩: PC
光源: SMD
整灯光效: 102 lm/W
显色指数: ≥83
色温: 3000K/4000K/6500K
输入电压: 220-240V
驱动电源: 高转换率驱动电源
灯具寿命: 3万小时
电气等级: I

Product name: 705 Suspended luminaire
Type: Suspended
Housing material: High-quality Aluminum alloy
Surface finish: Electrostatic thermo-painting
Diffuser material: PC
Light source: SMD
Luminaire efficiency: 102 lm /W
CRI: ≥83
Color temperature: 3000K / 4000K / 6500K
Input voltage: 220-240V
Driver: High efficiency driver
Lifespan: 30000h
Electrical grade: I

Niman 尼曼

705 吊灯

Suspended luminaires technical data sheet

705 尼曼圆管线性吊灯, 采用优质铝型材灯体, 无螺丝压铸铝端盖, 外观简约时尚, 半圆管状透光罩可提供120度照明, 再结合耐贝西创新的直接照明+间接照明的照明理念, 出光均匀无阴影, 防眩光效果好。先进的热管理技术, 散热效果优异, 确保了灯具最大光输出的持续性及色温的一致性。

应用场所: 写字楼, 学校、医院、高档超市、商场、公共建筑、机场车站等。

705 NIMAN linear suspended luminaire, housing made of high pressure extruded aluminum construction, die-cast aluminum end caps with no visible screws, semicircle tubular diffuser provides 120° illumination. The fashionable design with simple structure combined with the direct-indirect lighting concept which can provide uniform light output and excellent anti-glare effect. Advanced thermal management technology guaranteed the continuous high lumen output and constant CCT.

Application: Office building, school, hospital, supermarket, mall, hotel, and other public area and facility.

Indoor 室内适用	General lighting 基础照明	High efficiency 高光效	Long life 长寿命	Anti glare 防眩光	Accurate light distribution 准配光
No flickering 无频闪	IP 20 Protection level 防护等级	Protective grounding 保护接地	Fire protection 防火	Low lumen depreciation 低光衰	color-temp changing 调色温驱动电源
Microwave sensor 微波感应控制	Emergency kits 应急照明组件	DALI	light control 光控	Wifi or Ble, Zigbee	1-10V 1-10V dimming 1-10V调光
China Compulsory Certification 3C认证	CE certification CE认证	CB certification CB认证			

标准灯具 Standard single fitting

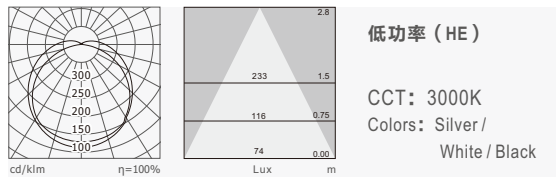
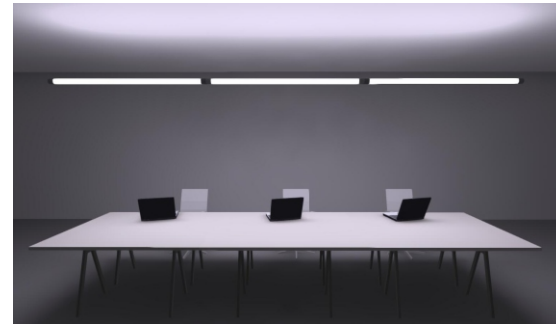
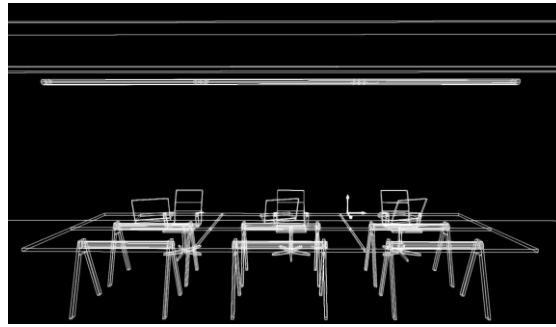

低功率 (HE)

CCT: 3000K
Colors: Silver /
White / Black

Item No	Power Flux	L*W*H
705-SS1150T18W	18W / 1836 lm	1150* φ 60
705-SS1710T27W	27W / 2754 lm	1710* φ 60

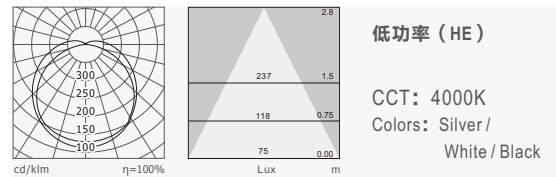

低功率 (HE)

CCT: 4000K
Colors: Silver /
White / Black

Item No	Power Flux	L*W*H
705-SS1150T18W	18W / 1856 lm	1150* φ 60
705-SS1710T27W	27W / 2774 lm	1710* φ 60

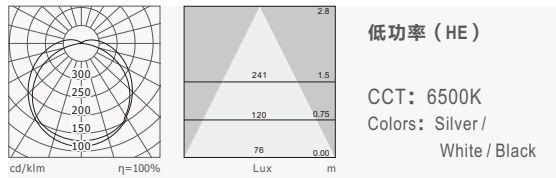

低功率 (HE)

CCT: 6500K
Colors: Silver /
White / Black

Item No	Power Flux	L*W*H
705-SS1150T18W	18W / 1876 lm	1150* φ 60
705-SS1710T27W	27W / 2794 lm	1710* φ 60

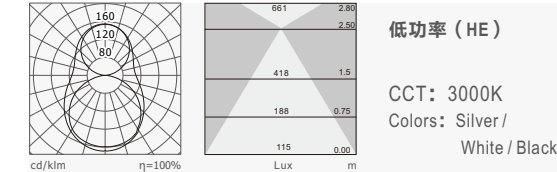
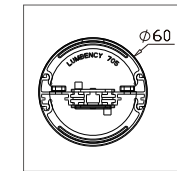
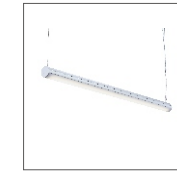

低功率 (HE)

CCT: 3000K
Colors: Silver /
White / Black

Item No	Power Flux	L*W*H
705U-SS1150T27W	27W / 2754 lm	1150* φ 60
705U-SS1710T40.5W	40.5W / 4131 lm	1710* φ 60

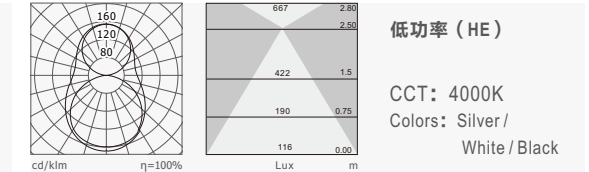

低功率 (HE)

CCT: 4000K
Colors: Silver /
White / Black

Item No	Power Flux	L*W*H
705U-SS1150T27W	27W / 2774 lm	1150* φ 60
705U-SS1710T40.5W	40.5W / 4151 lm	1710* φ 60

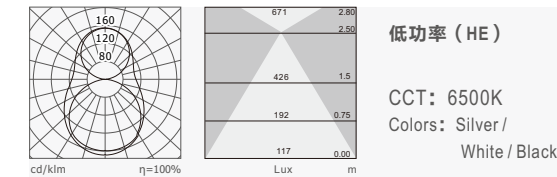

低功率 (HE)

CCT: 6500K
Colors: Silver /
White / Black

Item No	Power Flux	L*W*H
705U-SS1150T27W	27W / 2794 lm	1150* φ 60
705U-SS1710T40.5W	40.5W / 4171 lm	1710* φ 60

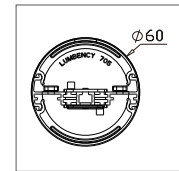
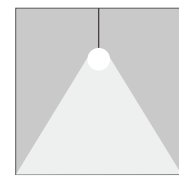

关联产品 Related products

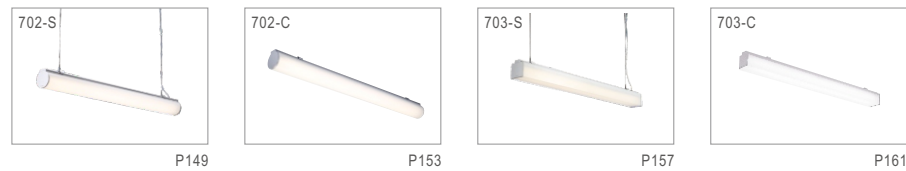

应用参考 Application reference

Open space: 10m x 10m x 3m; reflectance (%): ceiling80/wall50/floor20/ floor ceiling walls; illuminance is the average lux level on 0.75m working surface; "H" is the fittings installation height

开放式空间: 10m x 10m x 3m; 反射率(%): 天花板 80/墙壁50/地板20; 照度为 0.75m工作面平均照度; H为灯具安装离地高度。

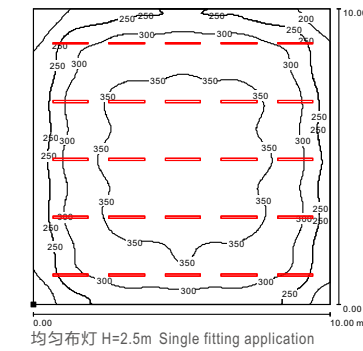

均匀布灯 H=2.5m Single fitting application

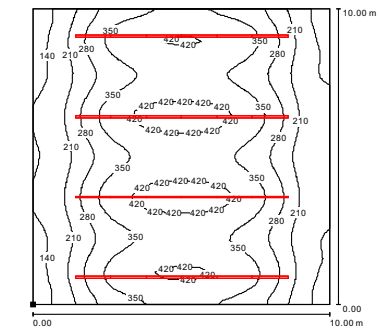

Item No	Power Flux	Number	W/m ²	H=2.8m Illuminance(Lux)
705-SS1150T18W	18W / 1836 lm	25	4.5	313
705-SS200T108W	108W / 11016 lm	4	4.32	304